

# 1/10TH SCALE ELECTRIC OFF-ROAD BUGGY / SHORT COURSE / DESERT BUGGY TRUCK / TRUGGY / MONSTER TRUCK HUMMER / RALLY CAR

## SHORT COURSE

ITEM NO. E10SC  
E10SCL



## BUGGY

ITEM NO. E10XB  
E10XBL



## DESERT BUGGY

ITEM NO. E10DB  
E10DBL



## MONSTER TRUCK

ITEM NO. E10BV  
E10BVL



## TRUGGY

ITEM NO. E10XT  
E10XTL



## TRUCK

ITEM NO. E10MT  
E10MTL



## RALLY CAR

ITEM NO. E10XR  
E10XRL



## HUMMER

ITEM NO. E10HM  
E10HML



## Before You Start Assembling

Thank you for purchasing our Ready To Run 1/10 scale electric off-road vehicle. This manual contains the basic methods of operation, assembly details, and related accessories. Operators less than 14 years of age need to be supervised by an adult. Please read all information in this manual before operation to avoid any damage or danger.

All operating instructions should be read before the use of this product. It contains important information for future reference. In addition, because we constantly update our products, some small physical features may change. Check our website for any update on changes.

## Tools Needed

2.5 2.0 1.5 Allen key

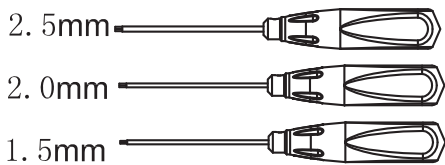

5.5 7 Wrench

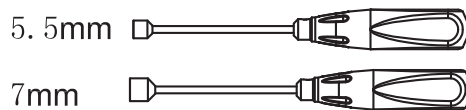

Cross Wrench(big)

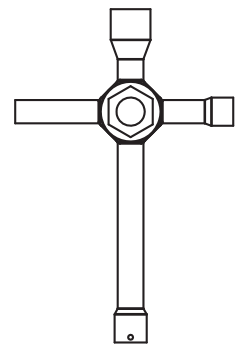

Needle Nose Plier

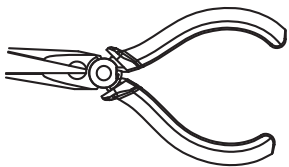

Hobby Scissors

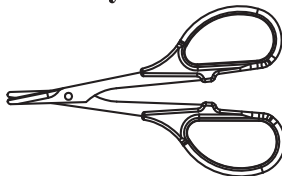

Cross Wrench(small)

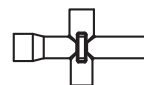

5.5mm Open end wrench

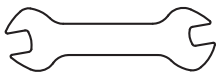

Charger

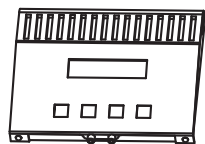

Reamer



Apply CA glue

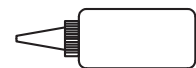

Grease



1.2V AA Battery

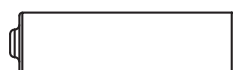

Silicone Oil

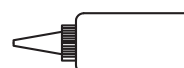

## ***Safety Precautions***

This is a high-quality radio control model. Pay attention at all times to insure careful operation. If care is not taken, loss of life and property may result. Children should not be allowed to operate in the absence of adult supervision. Operational errors, or the incorrect use of this product and important information included in this manual (which may result in the loss of life, severe injury or property damage), will be the responsibility of the owner.

----*This model is controlled by radio signals, which may be subject to outside interference beyond the control of vehicles radio system.*

----*Therefore, keep within a safe distance to avoid accidents and away from motor vehicles and people.*

----*Do not place or run on wet grass or in puddles because electronic equipment (servers, receivers and power transfer) is not waterproof. If you want to run in these areas the electronics must be waterproofed.*

----*Do not drive if battery power is low!*

----*Do not drive in poor conditions or vehicle damage may occur.*

----*Be careful to comply with the instructions and warnings of other equipment used (charger and battery, etc.).*

----*Put chemicals, metals, and electronic equipment out of the reach of children.*

----*Only careful and cautious use of remote control cars can protect life and property from harm.*

---

## ***Warranties***

Ask retailers for replacement or return for manufacturing defective or missing parts. There is no warranty against wear and tear caused by incorrect operation or use of incorrect parts.

Retailers are to provide technical assistance free of charge for beginners.

---

## ***Operational Requirements***

First, make sure batteries are fully charged. Check all connections and settings .

Install 8AA batteries in the remote, ensure that the batteries have full power, pay attention to positive and negative polarity, and do not install in the wrong direction.

The remote control system has a variety of different functions and settings. Before initial use, ensure that all functions and settings have been fully understood.

**DIGITAL PROPORTIONAL SYSTEM****2.4GHZ MT-300****SYSTEM FEATURES**

Unique and functional pistol grip transmitter design  
 Well balanced for precise control  
 Non-slip foam steering wheel  
 Well placed digital trim & D/R levers  
 Optimum third channel switch location  
 Low Battery warning  
 Quick Binding and Fail Safe Setup  
 High performance micro 3 channel receiver  
 NiCd charger jack in transmitter  
 Sound Beep

**SYSTEM SPECIFICATIONS**Transmitter**Model:** MT-300TX**FHSS Output Power:** <100mW**Operating Voltage:** 4.2V~7V**Power Supply:** 4 Cell Alkaline/Ni-Cd/Ni-MH**Weight:** 13.9 oz (394 gr) with Alkalines**Frequency/Modulation Type:** 2.4GHz FHSSReceiver**Model:** MT-300RX**Frequency:** 2.4GHz FHSS**Operating Voltage:** 3.6V~7V**Weight:** 0.26 oz (7.4gr)**Dimensions:** 1.38 x 1 x 0.5 in (35.1 x 25.3 x 13 mm)**Fail Safe:** Yes (All Channels)**FEATURES DESCRIPTIONS**

**Receiver Antenna Wire:** The antenna wire receives the transmitter signal. The antenna wire should be installed through a nylon tube (antenna tube) in the vertical position for the best reception.

**Auxiliary Channel 3 Switch:** Controls Auxiliary Channel 3 High and Low servo travel.

**Battery Compartment:** Houses the 4 'AA' Alkaline batteries that power the transmitter.

**Bind Button:** Used in the process of Binding the transmitter and receiver.

**Bind LED:** Displays the current status of the transmitter and receiver pair.

**Steering Dual Rate(D/R):** The Dual Rate Keys are used to adjust the Steering Dual Rate quickly and easily during use.

**Grip:** The Grip is molded in an ergonomic shape for increased comfort, control and feel.

**Power Indicator:** Indicates that there is Power to the transmitter.

**Power Switch:** Turns the transmitter ON and OFF.

**Steering Trim Lever (CH1):** Used to adjust the center Trim of the Steering servo.

**Steering Wheel(CH1):** Proportionally operates the model's right and left steering control. The Steering Wheel features a molded grip for increased comfort, control and feel.

**Throttle Trigger(CH2):** Controls the speed of the model, both forward and backward, or the model's brake.

**Throttle Trim Lever (CH2):** Used to adjust the center Trim of the Throttle servo.

**TRANSMITTER AND RECEIVER DIAGRAMS**

Use the diagram below to familiarize yourself with the different parts of your **MT-300TX** transmitter and **MT-300RX** receiver.

Descriptions of these parts can be found in the transmitter and receiver layout.

 The transmitter antenna is mounted internally and is located in the front portion of the transmitter. When you're driving your model, hold the transmitter so that it's orientated as close to vertical as possible at all times and try not to 'follow' your model with the transmitter. This provides the best RF signal between the transmitter and the receiver. Do NOT cover the front of the transmitter in any way during use! Doing so can block the RF signal, resulting in the loss of control of your model.



## FRONT

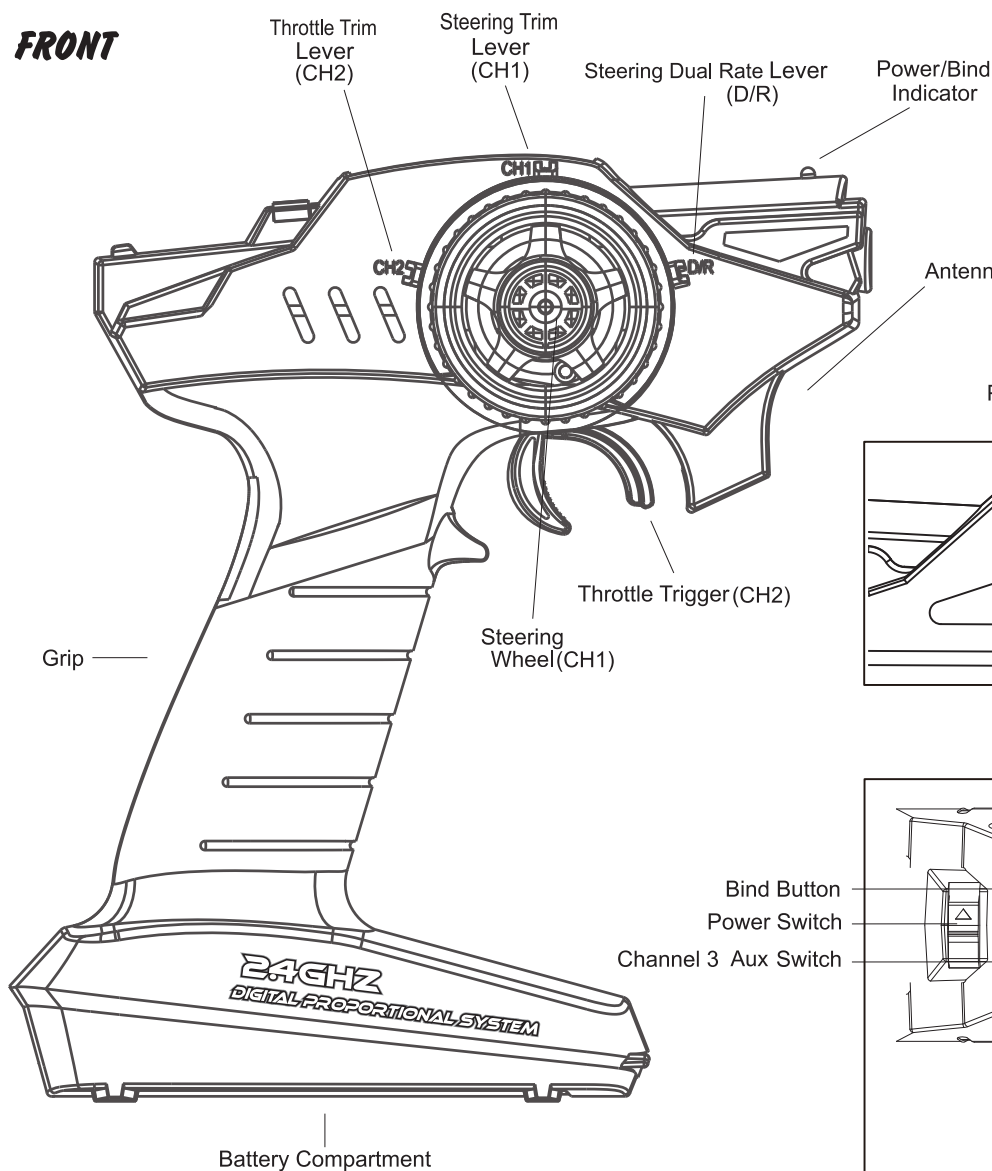

## BACK

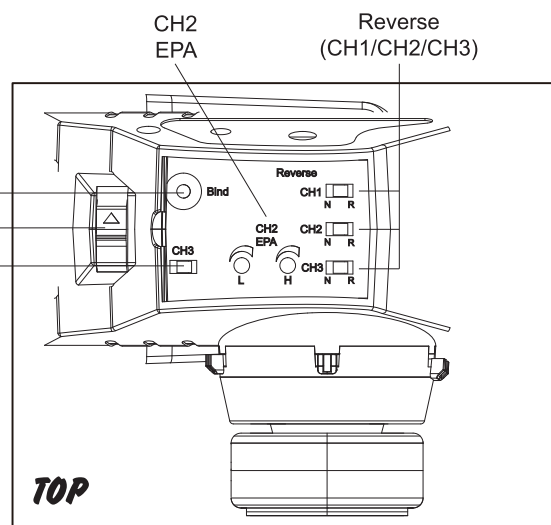
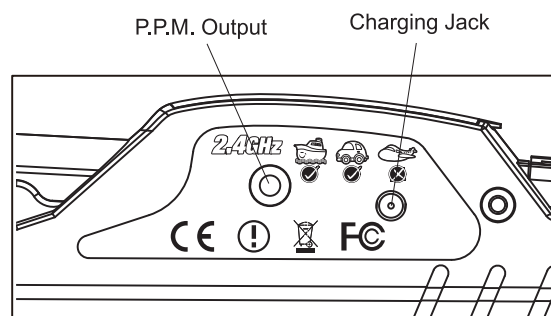

## RECEIVER

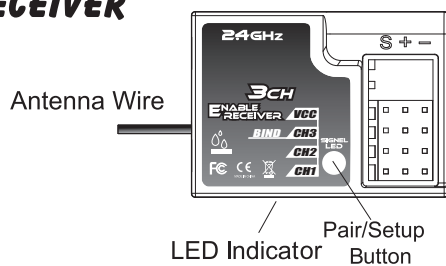

## Channel Output

- "1": Steering (CH1)
- "2": Throttle (CH2)
- "3": AUX (CH3)
- "B": Power

## TRANSMITTER BATTERY INSTALLATION

To Open slide cover

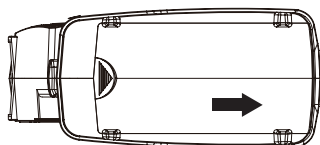

Install Batteries

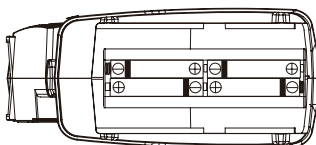

To Close slide cover

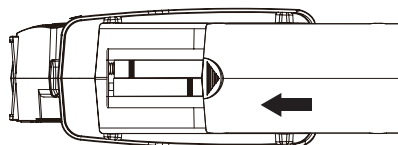

1. Press down on the battery cover and slide in the direction of the arrow to remove.
2. Install 4 AA alkaline cells (or Ni-Cd, or Ni-MH) as indicated inside the battery compartment. Make sure to match the polarity (+ and -) as shown in the battery compartment or the transmitter will not function.

3. Install the battery cover in place and slide to close.

**WARNING:** Improper installation of transmitter batteries can cause serious damage to your system.

## RECEIVER CONNECTIONS AND MOUNTING

Use the diagram below to familiarize yourself with how to connect the switch harness, servos (available separately), and the 4 cell battery holder to your **MT-300RX** 3-Channel receiver.

1) Install four fresh 'AA' Alkaline batteries into the battery holder, making sure that the polarity is correct. The direction that each battery should be installed is molded into the battery holder (+ Positive and - Negative).

 The **MT-300RX** 3-Channel receiver's Nominal Input Voltage is **3.6v~7v**, therefore, the receiver can be powered using a 4 or 5 cell Ni-Cd or Ni-MH battery pack (available separately).

- We suggest Binding the transmitter and receiver and setting the Fail Safe position, prior to mounting the receiver in your model.

- The receiver should be mounted as far away from any electrical components as possible.

- Route the antenna wire up through a plastic tube so that it is in the vertical position.

- To protect the receiver from vibration and other damage, we recommend wrapping the receiver in shock absorbing foam rubber when installing it in your model.

 Set your model on a stand so the wheels are off the ground before turning on your radio control system or connecting your motor for the first time.

 The receiver does not feature BEC circuitry. If using an electronic speed control, verify that it features BEC circuitry to drop the receiver voltage between 3.6v~7v.

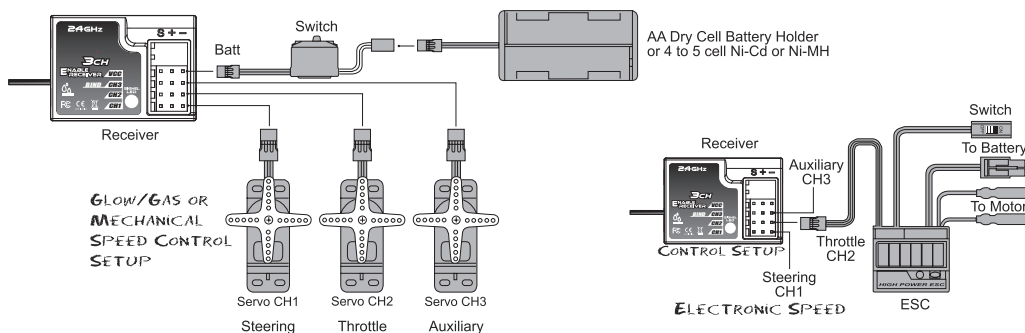
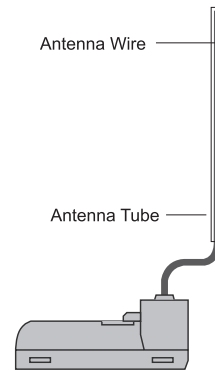

## RECEIVER'S ANTENNA INSTALLATION

The wave length of the 2.4GHz is much shorter than that of the conventional frequencies, it is very susceptible to loss of signal which results in a receiving error.

To obtain the best results, please refer to the following instructions;

1. The antenna must be kept as straight as possible. Otherwise it will reduce the effective range.

2. The antenna should be perpendicular to the model. Larger models can have large metal objects that can attenuate the RF signal. In this case the antennas should be placed at sides of the model. Then the best RF signal condition is obtained at any attitude.

3. The antennas must be kept away from conductive materials, such as metal and carbon by at least a half inch. The coaxial part of the antennas does not need to follow these guidelines, but do not bend it in a small radius.

4. Keep the antennas away from the motor, ESC, and other noise sources as much as possible.

\*The main purpose of the photo demonstrates how the antenna should be placed. For actual installation the receiver must be wrapped with a sponge or placed with floating material to protect it from vibration.

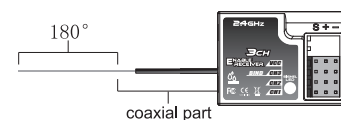

The receiver contains precision electronic parts. It is the most delicate radio component on-board the model and should be protected from vibration, shock and temperature extremes. To protect the receiver, wrap it in R/C foam rubber or other vibration-absorbing material. If appropriate, waterproof the receiver by placing it in a plastic bag and closing the open end with a rubber band before wrapping it in foam. If moisture enters the receiver, intermittent operation or a failure may result. Wrapping the receiver in a plastic bag also protects it from fuel and exhaust residue which, in some models, can work its way into the model.

## STEERING TRIM(CH1)

Steering neutral adjustments can be made by moving the steering trim lever to the left or right. When you install a servo, always check to be sure the servo is at its neutral position. Adjust the servo horn position and linkage so both are parallel. Be sure the steering trim on the transmitter is at the neutral position.

### Trim Operation And Maximum Travel

Changing the trim can affect the overall settings. When adjustments are made with the trims, recheck your installation for maximum travel. (Steering D/R at 100%)

### When Trim Usage Is Extreme

If it takes most of your trim movement to get a servo to the neutral position, reposition the servo horn from the servo and inspect your linkage installation.

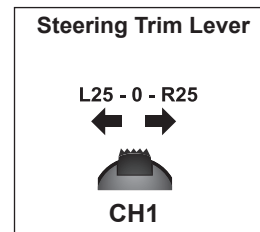

## THROTTLE TRIM(CH2)

Throttle neutral adjustments can be made by moving the throttle trim lever to the up or down. When using an electronic speed control, set the throttle trim to neutral and make adjustment to the speed control. On a gas powered model, set the trim to neutral and adjust the linkage to the point where the carburetor is fully closed in accordance with the engine instruction manual.

### Trim Operation And Travel

Trim adjustments will affect the overall servo travel. Check the brake side (backward) movement when changes are made.

### When Trim Movement Is Extreme

If you use most of the trim movement to get the servo to the neutral position, recenter the servo horn closer to the neutral position and inspect your throttle linkage.

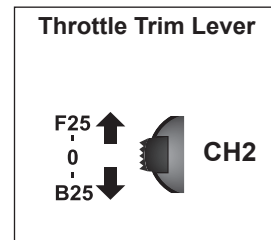

## STEERING DUAL RATES(D/R-CH1)

Use this function to adjust the steering travel of your model. If the model understeers while cornering, add steering by pressing the lower side of the D/R button. When the model oversteers, take away steering by pressing the upper side of the D/R button.

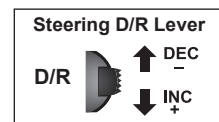

## THROTTLE END POINT ADJUSTMENT(EPA-CH2)

This function is used to adjust the forward and brake side servo travel. Each direction can be adjusted independent of each other. Use this feature to set the throttle servo travel.

 Be sure that your throttle linkage does not apply excessive force to the servo. If your linkage installation causes an unreasonable amount of force to be applied to the servo, the servo may be damaged and result in loss of control.

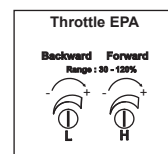



## TRANSMITTER AND RECEIVER BINDING

The Binding function allows you to Bind the transmitter and receiver pair. When new, it is necessary to pair the transmitter and receiver to prevent interference from radio controllers operated by other users. This operation is referred to as 'binding'. Once the binding process is complete, the setting is remembered even when the transmitter and receiver are turned OFF. Therefore, this procedure usually only needs to be done once.

 Before beginning the binding process, connect the switch harness, servos, and the receiver battery to your **MT-300RX** 3-Channel receiver, using the diagram on page 5. Make sure that both the transmitter and the receiver are turned OFF.

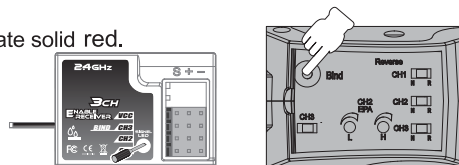
- 1) Turn the transmitter ON. The Power Indicator on the transmitter will illuminate solid red.
- 2) Press and hold the receiver setup button, then turn the power switch on the ON position. The receiver LED will flash quickly. Release the setup button after 1 second.
- 3) Press and hold the binding button on the transmitter for 1 second until the LED on the receiver is continuously lit.



 When the binding process is successful, the Bind LED on the receiver will stay solid red when both the transmitter and receiver are turned ON. If the Bind LED on the receiver is flashing rapidly or not illuminated at all, the transmitter and receiver are not paired. In this case, turn both the transmitter and receiver OFF, then repeat the binding process.

 Under some circumstances, the receiver may not operate after turning the transmitter and receiver ON. If this occurs, perform the binding process again.

Please note the setup must be based on pair procedure well.

1. Turn the power switch on the transmitter & receiver to the ON position, the LED on transmitter & receiver are continuously lit.
2. Move the steering wheel or throttle trigger to the position where you want the servo to move, press and hold the receiver setup button for 2 second until the red LED on the receiver flash slowly, then press and hold the receiver setup button again within 5 seconds (Note: after 5 seconds F/S setup will reset, you have to start over at step one above) until the receiver LED is continuously lit, that's mean the F/S function has been correctly set.
3. Verify if the failsafe function has been correctly set. Turn off the transmitter, then check if the servos moves to the position that you set.
4. Any new binding (pair procedure) will clear the preset Fail-Safe.



# PDF Compressor Pro Explode Diagram of the Buggy

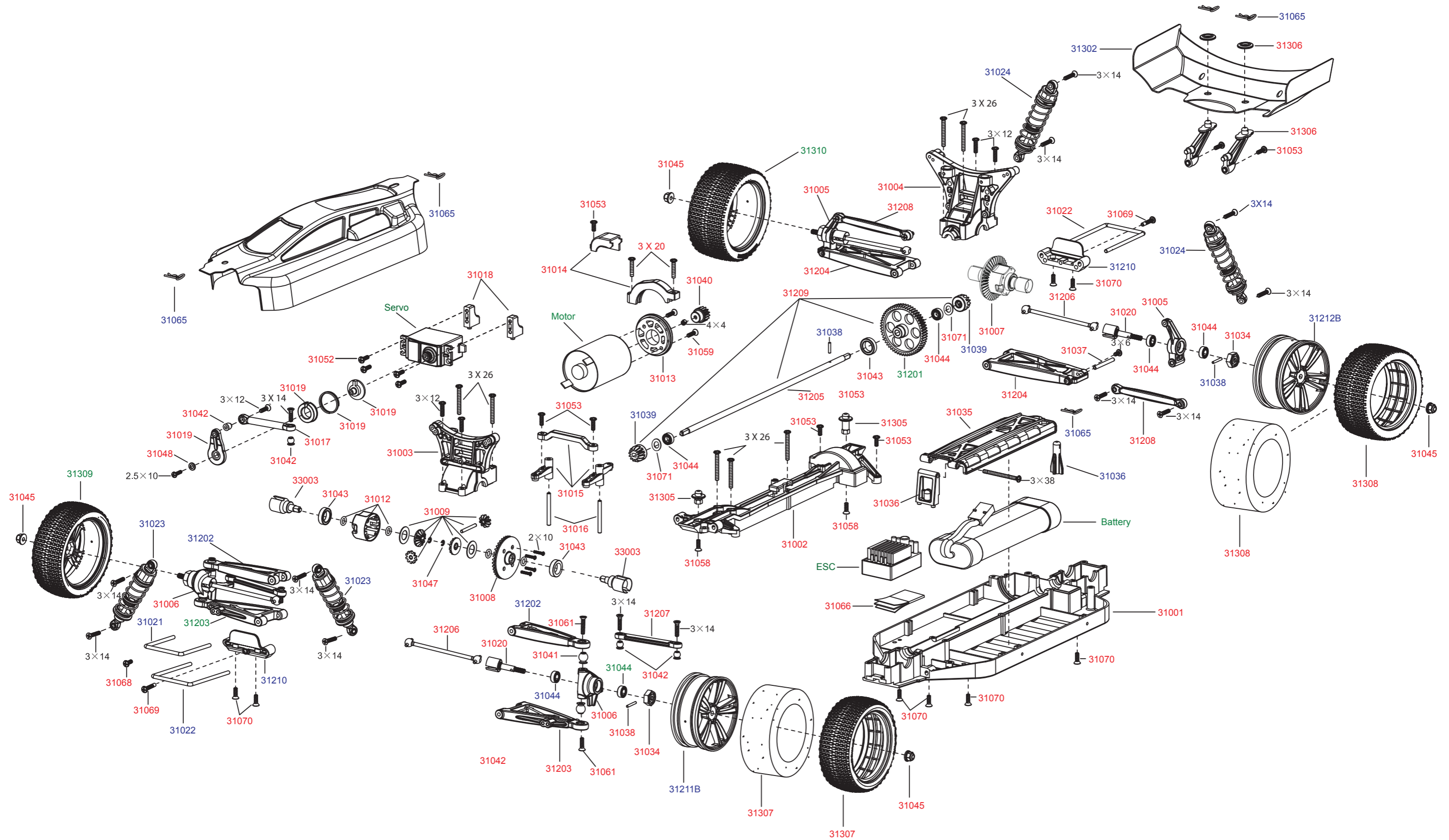

# Explode Diagram of the Short Course Truck

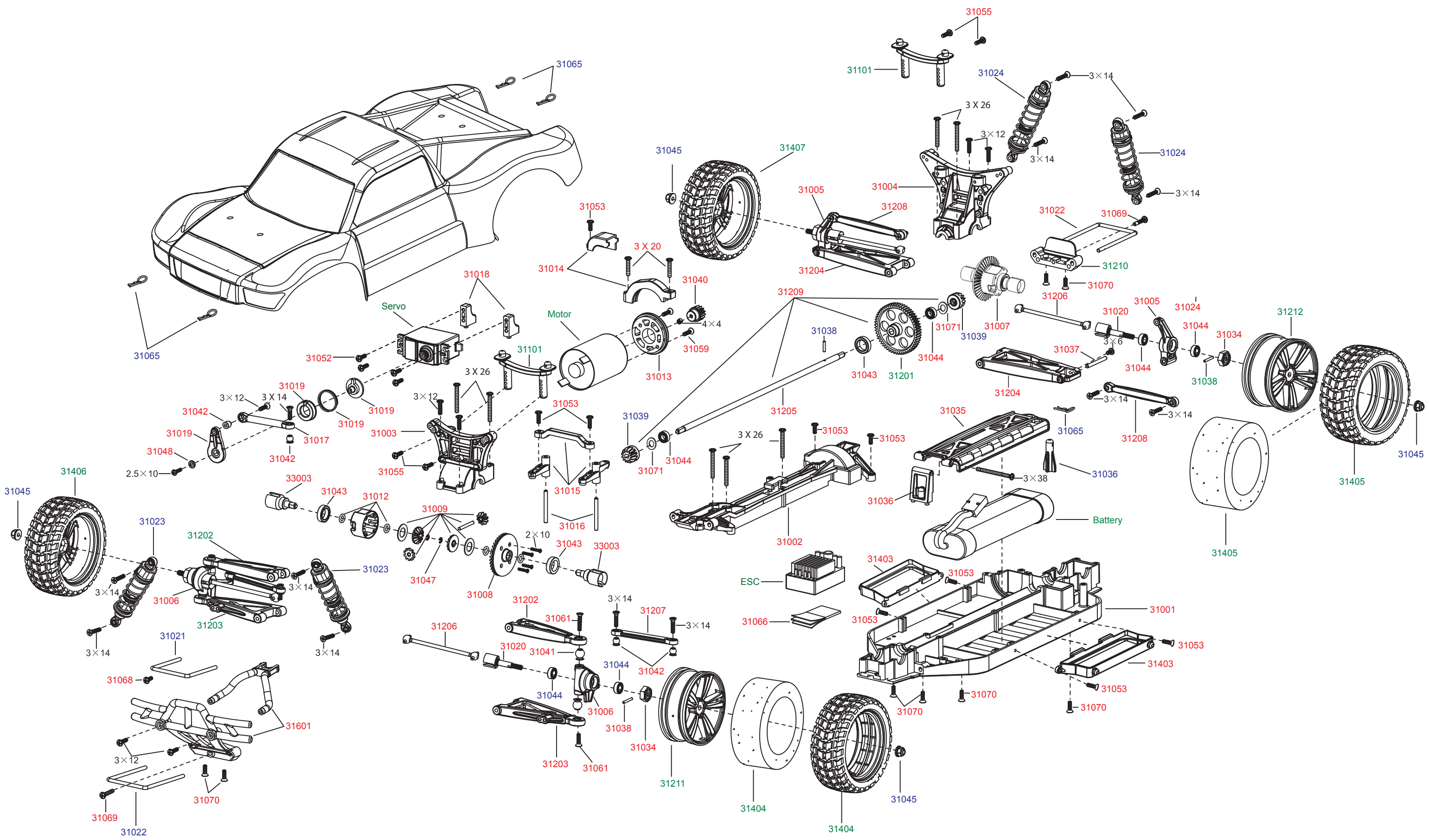



# Explode Diagram of the Truggy

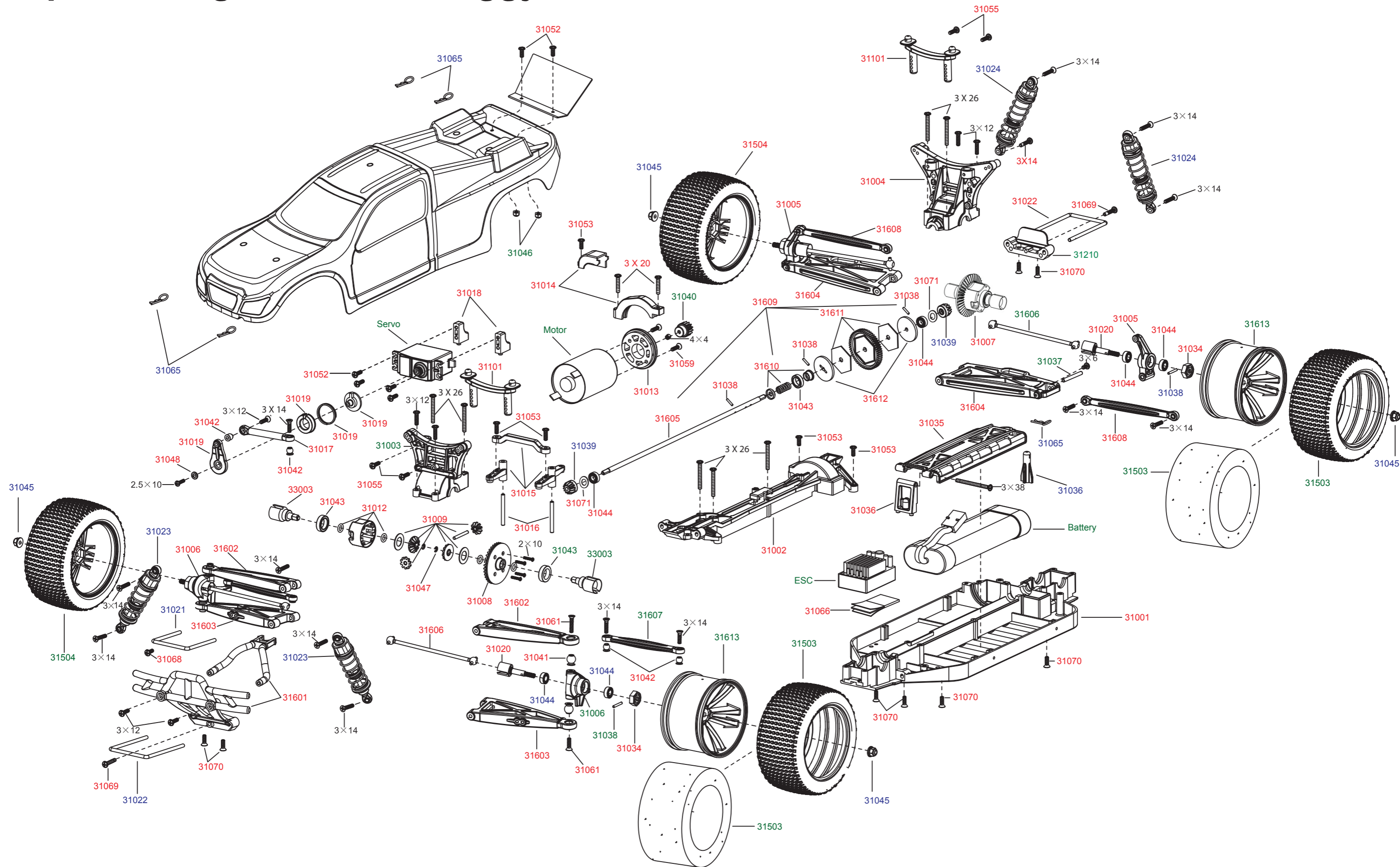

# Explode Diagram of the Truck

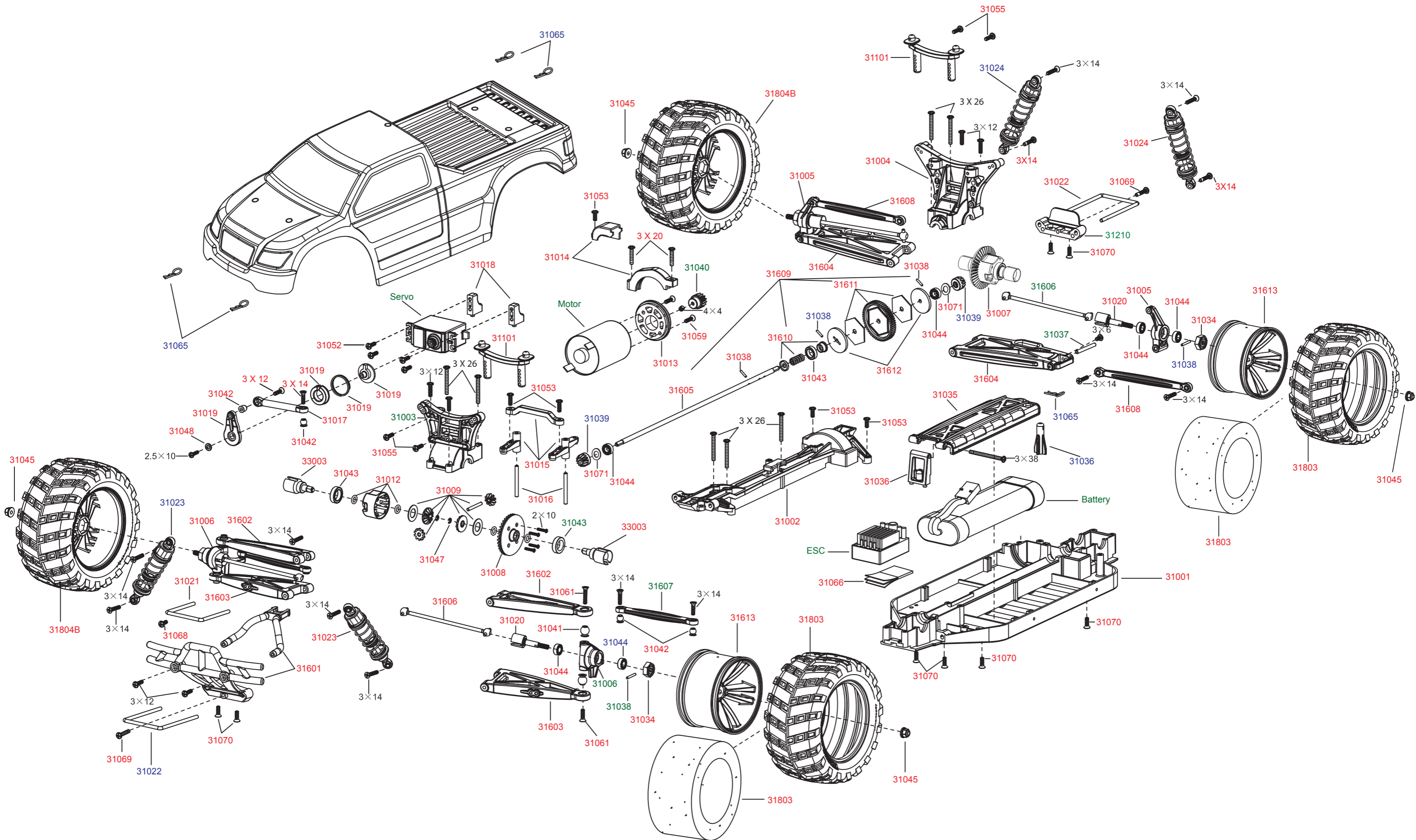



# Explode Diagram of Monster Truck

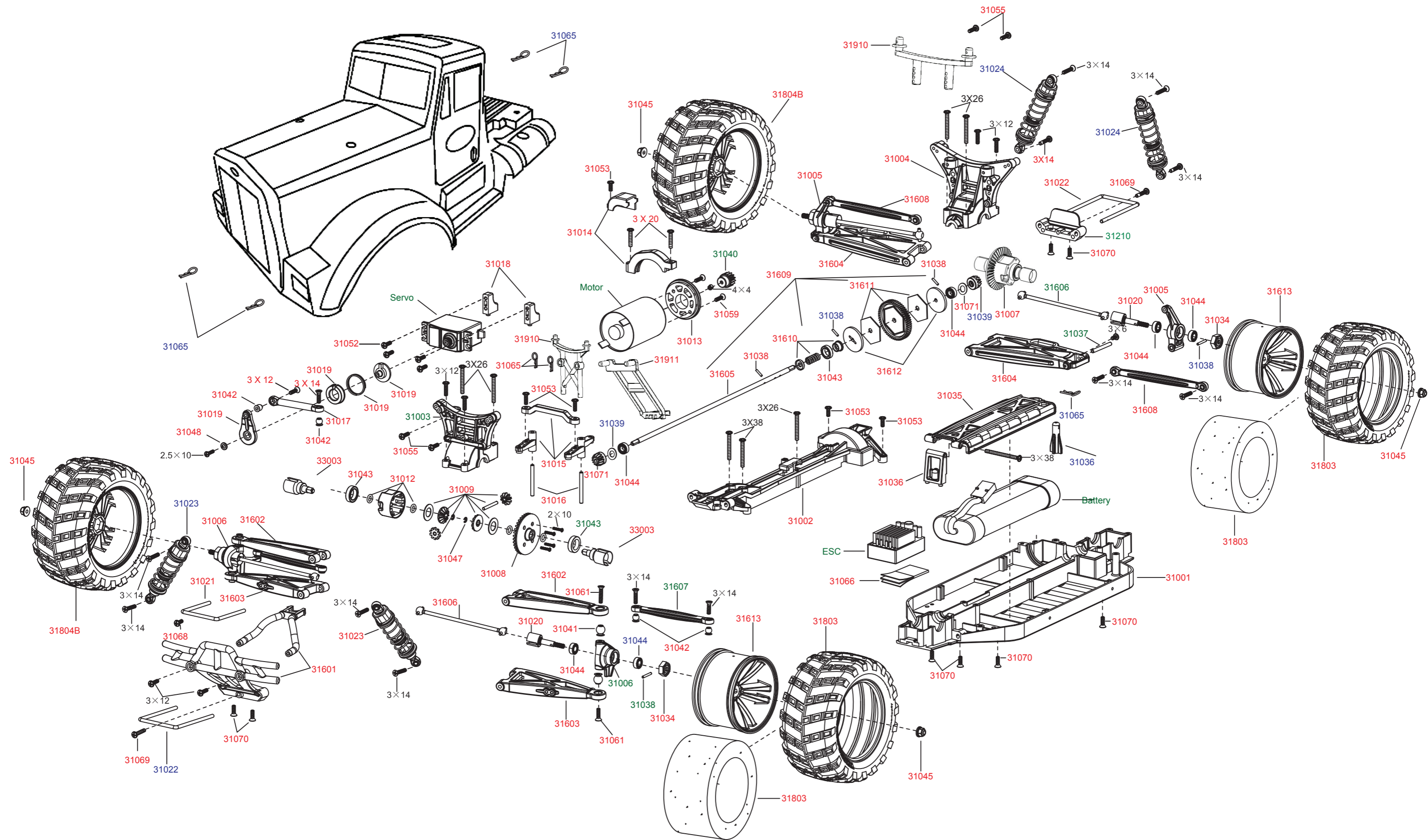





# Explode Diagram of the Rally Car

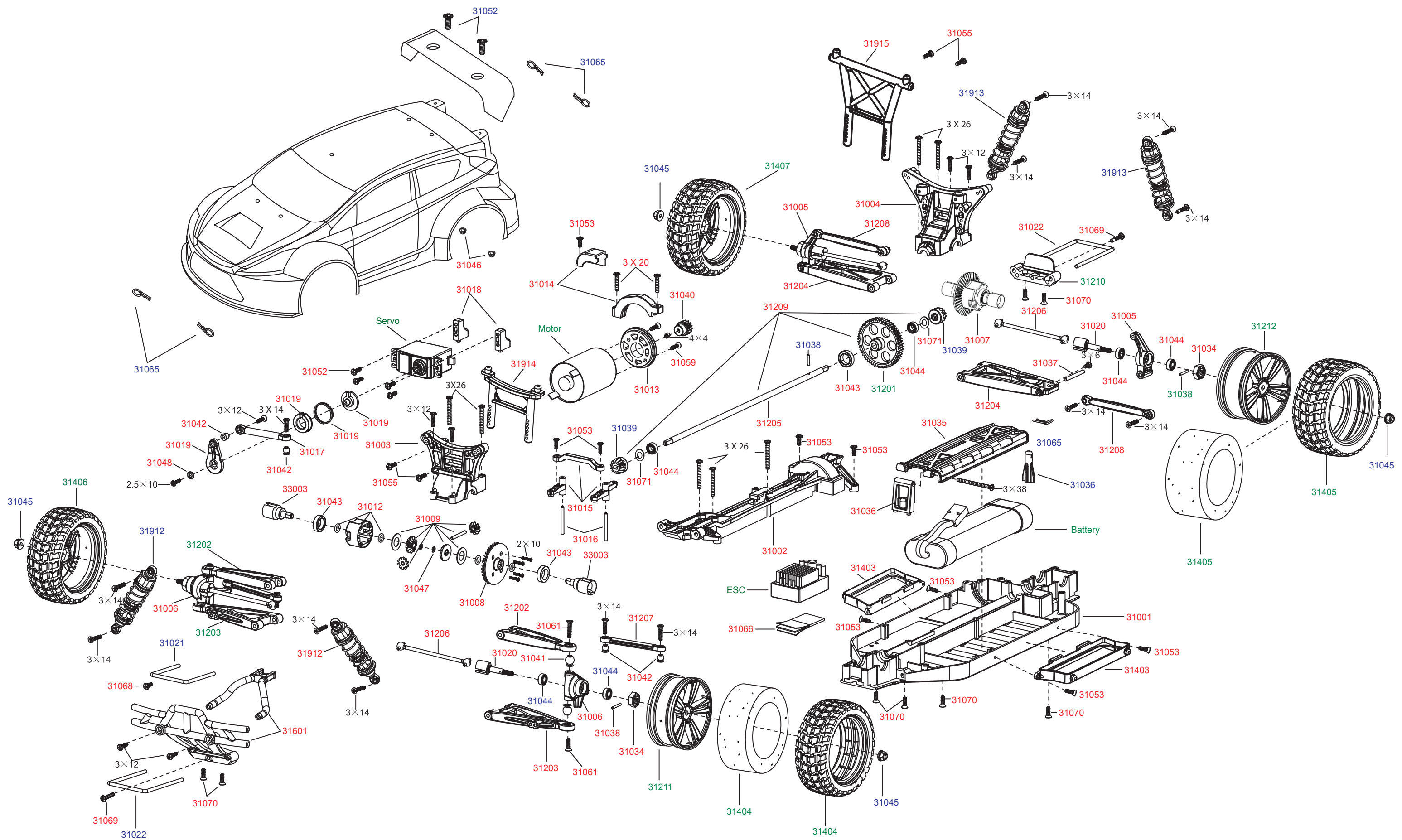



# Explode Diagram of the Desert Buggy

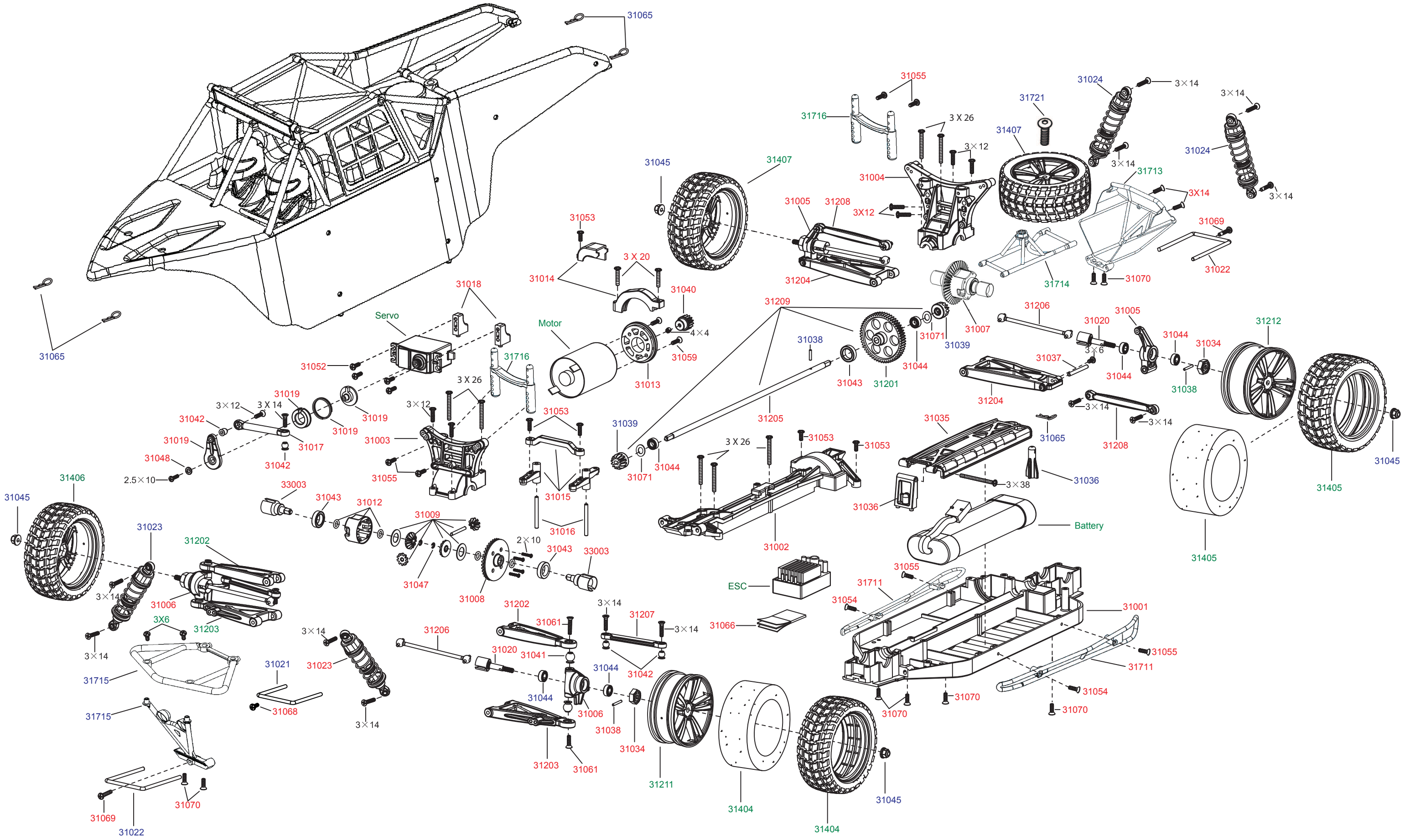

# PDF Compressor Pro

## Explode Diagram of the Desert Buggy

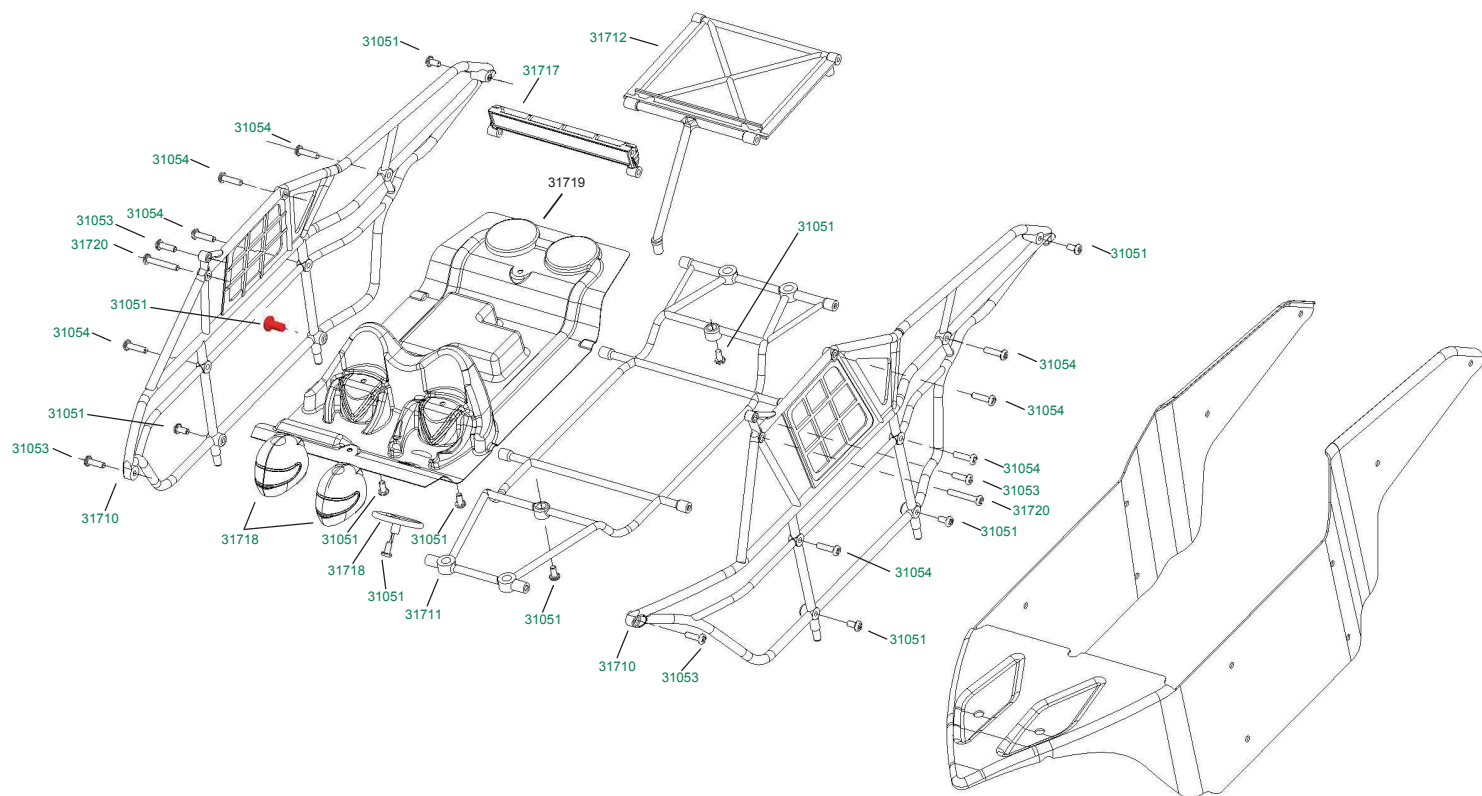

### Service and Maintenance

In order not to void car warranty, always keep your buggy clean. In areas of high dust and dirt, be sure to blow off dirt and dust with a compressor, soft bristle brush, or toothbrush.

Always check car for loose or broken parts and replace before and after running.

Regularly check screws to make sure that they are tight.

Replacement parts are available at many local retailers or online stores. Feel free to contact retailers for help in replacing parts.

### SPECIFICATIONS

Model	Code	Length	Width	Height	Wheelbase	Wheel Dia.	Wheel Width	Gear Ratio
BUGGY	E10XB	409mm	256mm	139mm	288mm	85mm	254mm	9.6
TRUCK	E10MT	422mm	335mm	163mm	296mm	116mm	332mm	11.7
TRUGGY	E10XT	432mm	330mm	144mm	296mm	106mm	329mm	10.9
SHORT COURSE	E10SC	453mm	256mm	144mm	288mm	90mm	254mm	10.2
MONSTER TRUCK	E10BP	440mm	335mm	260mm	296mm	116mm	332mm	11.7
DESERT BUGGY	E10DB	500mm	256mm	190mm	288mm	90mm	254mm	10.2
HUMMER	E10HM	420mm	253mm	180mm	288mm	90mm	254mm	10.2
RALLY CAR	E10XR	520mm	260mm	175mm	288mm	90mm	254mm	10.2

# STANDARD PARTS LIST

**31001**

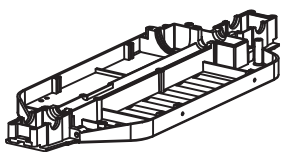

Chassis

**31002**

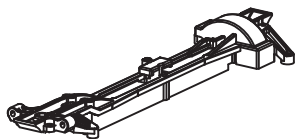

Upper Deck

**31003**



Front Shock Tower

**31004**

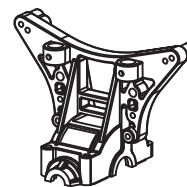

Rear Shock Tower

**31005**

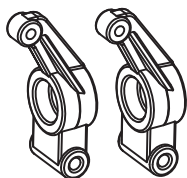

Rear Hub

**31006**

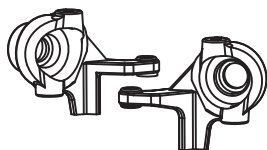

Knuckle Arms

**31007**

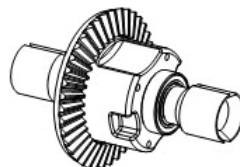

F/R Differential Gear

**31008**



Differential Crown Gear 38T and Sealing

**31009**

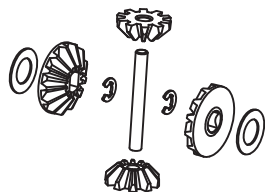

Differential Bevel Gear

**33003**

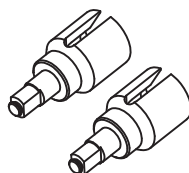

Differential Outdrives

**31012**

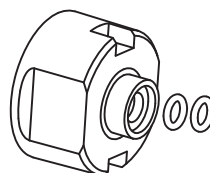

Differential Case and Sealing

**31013**



Motor Mount

**31014**

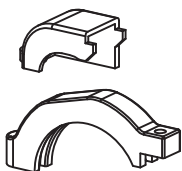

Motor Support Mount

**31015**

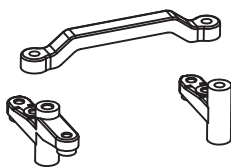

Front Servo Saver Arm

**31016**

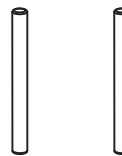

Steering Shaft

**31017**

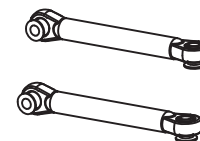

Servo Steering Linkage

**31018**

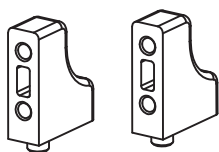

Servo Mounts

**31019**

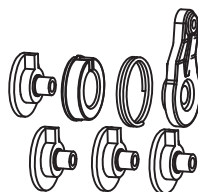

Servo Savers

**31020**

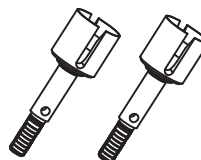

Wheel Axle

**31021**

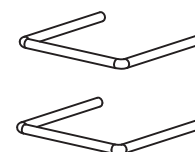

Upper Hinge Pin

**31022**

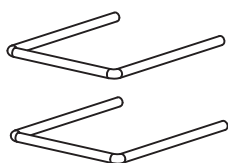

Lower Hinge Pin

**31023**



Front Shock Absorber  
(Not Suitable for XR)

**31024**

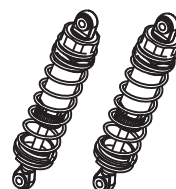

Rear Shock Absorbers  
(Not Suitable for XR)

**31601**

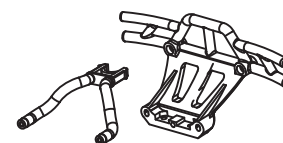

Bumper  
(Not Suitable for Desert Buggy/Buggy)



# STANDARD PARTS LIST

**31034**

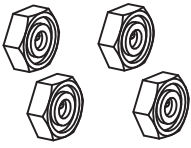

Wheel Nuts

**31035**

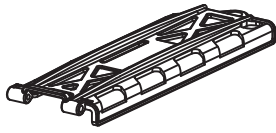

Battery Tray

**31036**

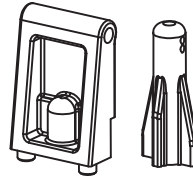

Battery Posts

**31037**

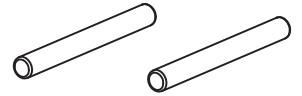

Lower Hinge Pin

**31038**

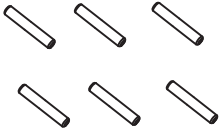

Pins 2X10

**31039**

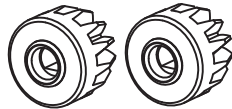

Differential Pinion Gear

**31040**

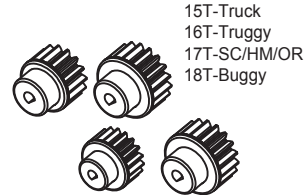

Nylon Pinion Gears  
15T,16T,17T,18T

15T-Truck  
16T-Truggy  
17T-SC/HM/OR  
18T-Buggy

**31041**

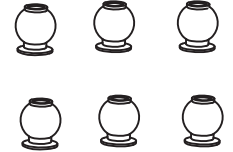

Ball Head (8.0mm)

**31042**



Ball Head (5.80mm)

**31043**

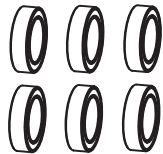

Ball Bearings 15X10X4

**31044**

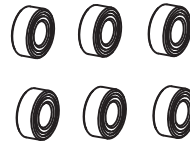

Ball Bearings 10X5X4

**31045**



Lock Nuts M4

**31046**

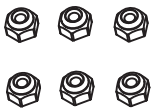

Lock Nuts M3

**31047**



E-Clips 2.5

**31048**

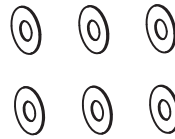

Shims 7.9X3.3X0.5

**31049**



Button Head Screws 2X10

**31050**

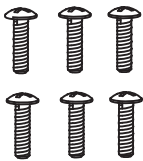

Button Head Screws 2.5X10

**31051**

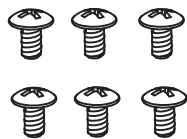

Button Head Screws 3X6

**31052**

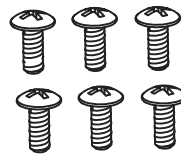

Button Head Screws 3X8

**31053**



Button Head Screws 3X10

**31054**

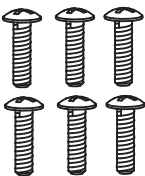

Button Head Screws 3X12

**31055**

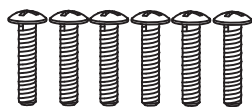

Button Head Screws 3X16

**31056**

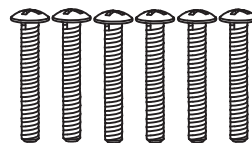

Button Head Screws 3X26

**31057**

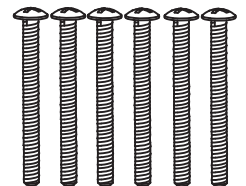

Button Head Screws 3X38

# STANDARD PARTS LIST

**31058**



Flat Head Screws 3X8

**31059**

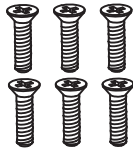

Flat Head Screws 3X12

**31060**

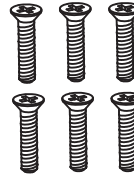

Flat Head Screws 3X14

**31061**



Flat Head Screws 3X16

**31062**

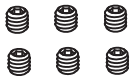

Grub Screws M3X3

**31063**

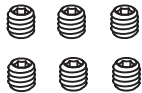

Grub Screws M4X4

**31064**



Plastic Cable Ties

**31065**



Body Clips

**31066**



Foam Double Side Tape

**31067**

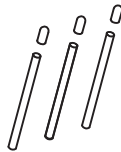

Antenna Pipe

**31068**



Cap Head Screws 3X8 6P

**31069**

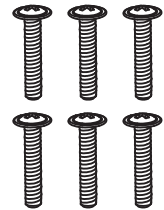

Cap Head Screws 3X16 6P

**31070**



Flat Head Screws 3X10 6P

**31071**

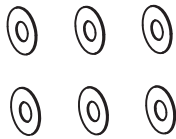

Shims 9 X 5.1 X 0.8

**31720**

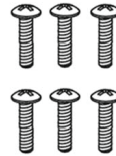

Button Head Screw 3X20

**03300**

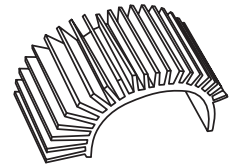

Motor Heat Proof Cover

**31210**

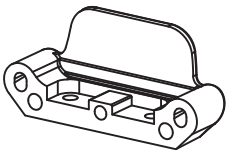

Susp Hinge Pin Holder  
(Not Suitable for Desert Buggy)

**31101**

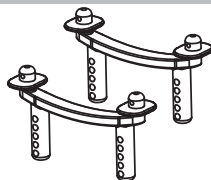

Body Mount for Trucks  
(Not Suitable for DB/XB/HM/XR/BP)



31201

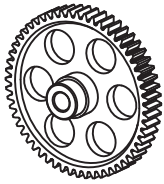

Main Gear 56T

31202

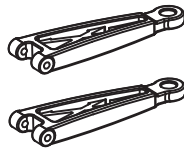

Front Upper Susp Arm

31203

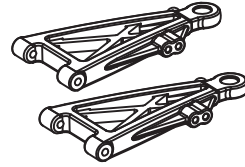

Front Lower Susp Arm

31204

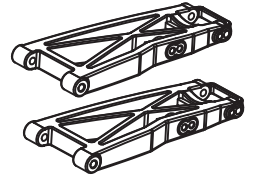

Rear Lower Susp Arm

31205



Alum Center Driveshaft

31206

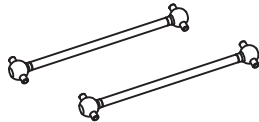

Dogbone (77.3mm)

31207

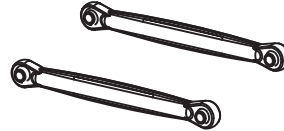

Steering Linkage

31208

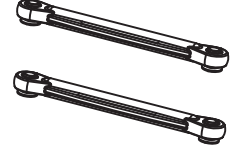

Rear Upper Linkage

31209



Center Driveshaft Complete with Gear

31211

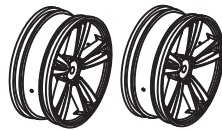

Front Wheel

31212

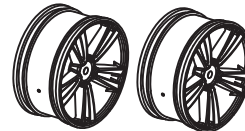

Rear Wheel

31403

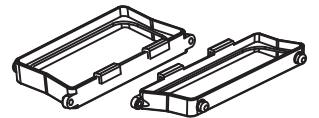

Side Body Mounts for SC, HM, XR

31404

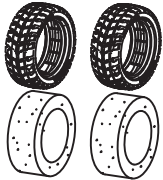

Front Tires for SC, DB, HM, XR

31405

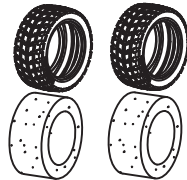

Rear Tires for SC, DB, HM, XR

31406



Front Tires and Rims for SC, DB, HM, XR

31407

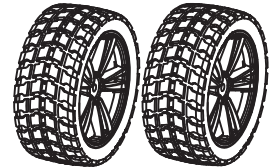

Rear Tires and Rims for SC, DB, HM, XR

31302

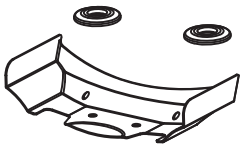

Wing for Buggy

31305

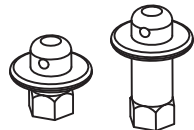

Buggy Body Mount

31306

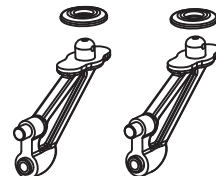

Buggy Wing Support

31307

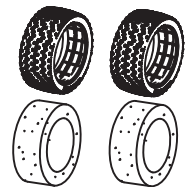

Buggy Front Tires

31308

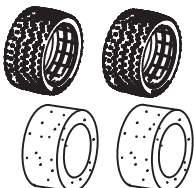

Buggy Rear Tires

31309

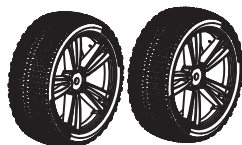

Front Tires and Rims For Buggy

31310

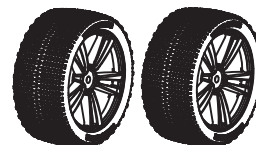

Rear Tires and Rims For Buggy

# DESERT BUGGY

**31700**



Desert Buggy Body(Blue)

**31701**



Desert Buggy Body(Red)

**31702**



Desert Buggy Body(Clear)

**31703**



Desert Buggy Body(Plain Red)

**31710**

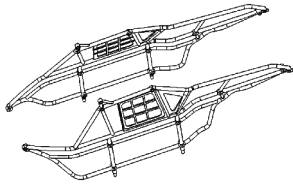

Side Roll Cage L&R

**31711**

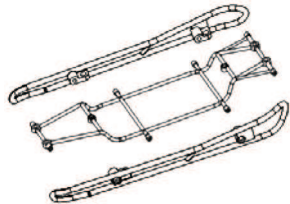

Roll Cage Center and Side Rails

**31712**



Roll Cage Top

**31717**

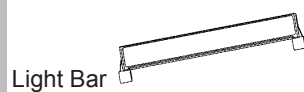

Light Bar

**31713**

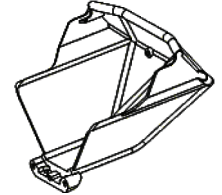

Rear Pod

**31714**

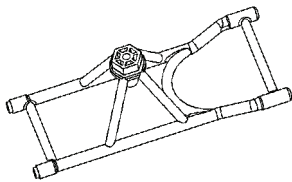

Roll Cage Rear Holder

**31715**

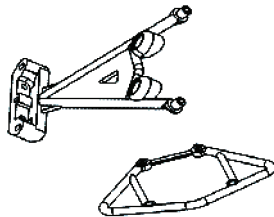

Roll Cage Front Bumper with Brace

**31716**

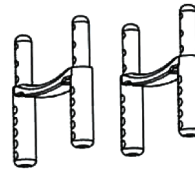

Body Post

**31718**

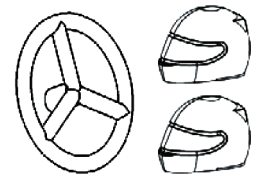

Driver Helmet and Steering Wheel Set

**31719BK**

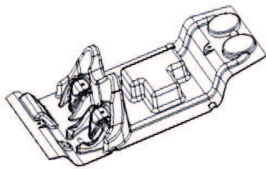

Cockpit(Black)

**31719BL**

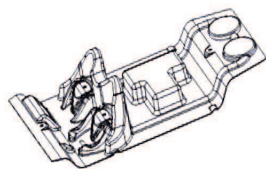

Cockpit(Blue)

**31721**



Flat Head Screw 4X20

**31722B**

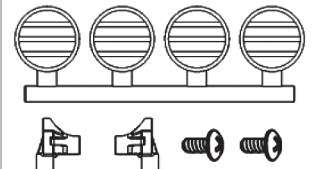

Optional LCD Light Set (Black)

# HUMMER, RALLY CAR

**31912**

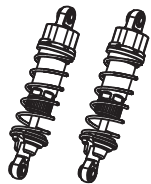

Front Shock Absorber (XR Only)

**31913**

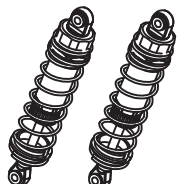

Rear Shock Absorbers (XR Only)

**31914**

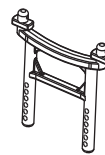

Front Body Post (HM/XR Only)

**31915**

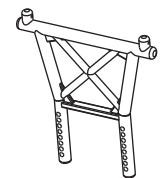

Rear Body Post (HM/XR Only)

**31916B**



Hummer Body (Blue)

**31916GD**



Hummer Body (Gold)

**31920G**



Rally Car Body (Grey)

**31920B**

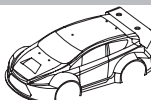

Rally Car Body (Blue)

**31916GY**



Hummer Body (Grey)

**31916CL**



Hummer Body (Clear)

**31920R**

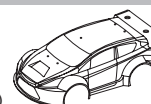

Rally Car Body (Red)

**31920CL**

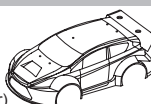

Rally Car Body (Clear)

# TRUGGY, TRUCK, MONSTER TRUCK

**31602**



Front Upper Susp Arm

**31603**

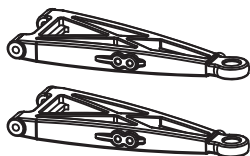

Front Lower Susp Arm

**31604**



Rear Lower Susp Arm

**31605**



Alum Center Driveshaft

**31606**

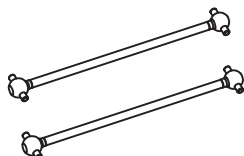

Dogbone (97.2mm)

**31607**



Steering Linkage

**31608**



Rear Upper Linkage

**31609**

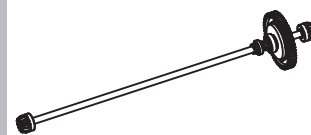

Slipper Clutch Complete with Gear

**31610**

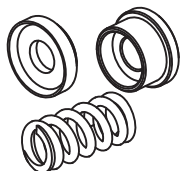

Spring Mount

**31611**

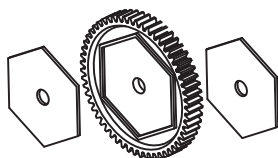

Main Gear 56T and Slipperpads

**31612**

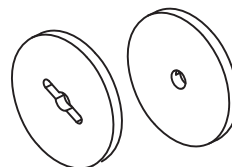

Slipper Plates

**31613**

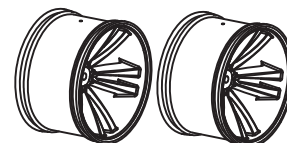

Wheels

**31803**

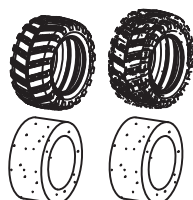

Tires for Truck/Monster truck

**31804**

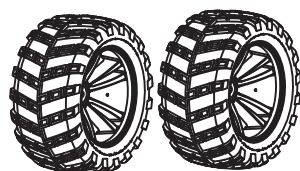

Tires and Wheels for Truck/Monster truck

**31503**

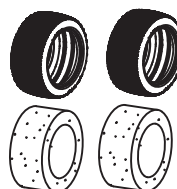

Tires for Truggy

**31504**

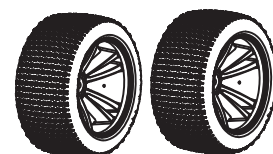

Tires and Wheels for Truggy

**31910**

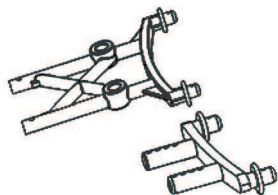

Body Post F&R (Monster truck)

**31911**

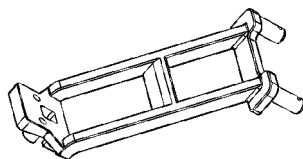

Front Brace (Monster truck)

**31900**

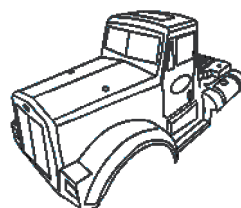

Monster truck Body (Blue)

**31901**

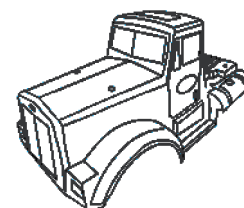

Monster truck Body (Red)

## OPTIONAL GEAR

**11170**

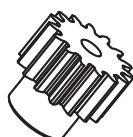

0.8 Module Copper Motor Gear (15T)

**11171**



0.8 Module Copper Motor Gear (16T)

**11177**



0.8 Module Copper Motor Gear (17T)

**11178**



0.8 Module Copper Motor Gear (18T)

## ELECTRONICS

**03016**

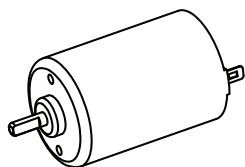

RC550 Motor

**03018**

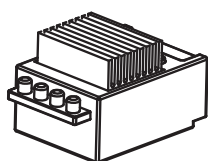

High power ESC

**2601**



Power Connector For  
Banana Plug

**SERVO6KG**

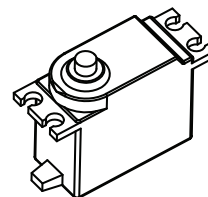

6Kg Servo Unit

**03014**



Battery Pack w/Tomyia Plug  
(7.2V, 2000mAH)

**03014B**



Battery Pack w/Banana Plug  
(7.2V, 2000mAH)

**03019B**



Battery Pack w/Banana Plug  
(7.2V,3000mAH) ( Optional )

**E020**

US Standard

**E021**  
EU Standard

**E022**  
AU Standard

**E023**  
UK Standard

NI-MH Battery Charger

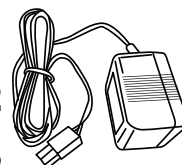

## ELECTRONICS FOR BRUSHLESS VERSION

**E028**

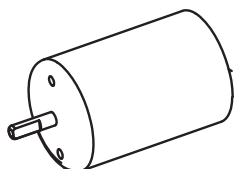

Brushless Motor

**E199**

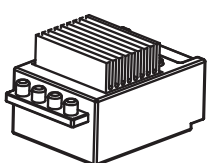

Brushless ESC

**SERVO6KG**

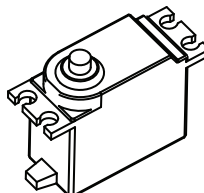

6Kg Servo Unit

**LP7420**



Li-Po Battery  
(7.4 V 2000mAh 2S 25C)

**A3US**

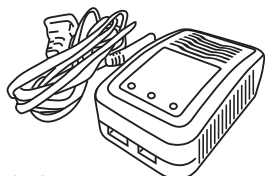

US Standard  
LiPo Balance Charger

**A3EU**

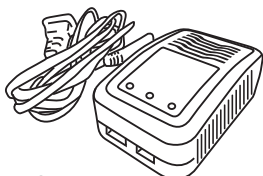

EU Standard  
LiPo Balance Charger

**A3AU**

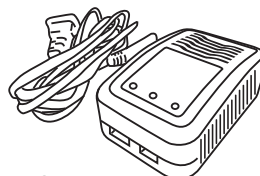

AU Standard  
LiPo Balance Charger

**A3UK**

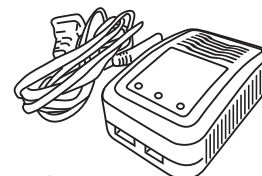

UK Standard  
LiPo Balance Charger

## TRANSMITTER & RECEIVER

**MT-300TX**

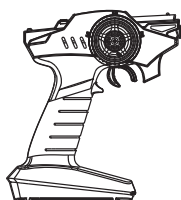

2.4 Ghz Transmitter

**MT-300RX**

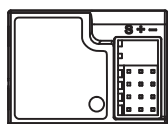

2.4GHz Receiver

**MT-300**

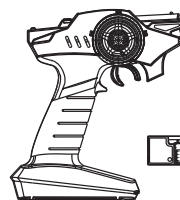

2.4 Ghz Radio Set



# OPTIONAL STANDARD PARTS

**33001**

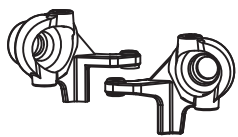

Alum Knucle Arm

**33002**

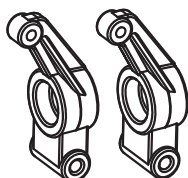

Alum Rear Hub

**33005**



Alum Front Shock Absorber

**33006**



Alum Rear Shock Absorber

**33009**

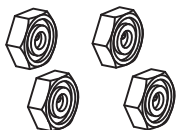

Alum Wheel Hub

# OPTIONAL PARTS SC, XB, DB, HM, XR

**33201**

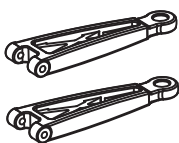

Alum Front Upper Susp Arm

**33202**

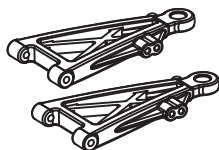

Alum Front Lower Susp Arm

**33203**

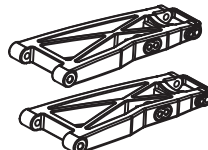

Alum Rear Lower Susp Arm

**33204**

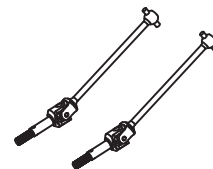

F/R Universal Shaft

**33205**

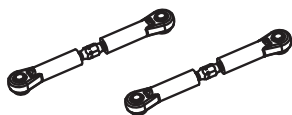

Alum Steering Linkage

**33206**

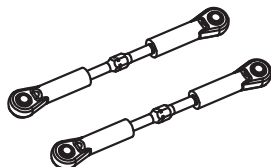

Alum Rear Upper Linkage

**E10MST-S1**

E10 Upgrade Set(SC, XB, DB, HM, XR)

# OPTIONAL PARTS TRUGGY, TRUCK, MONSTER TRUCK

**33601**



Alum Front Upper Susp Arm

**33602**

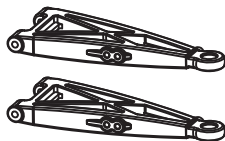

Alum Front Lower Susp Arm

**33603**

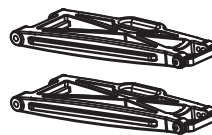

Alum Rear Lower Susp Arm

**33604**

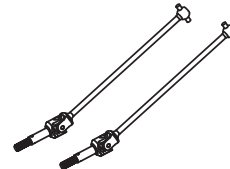

F/R Universal Shaft

**33605**

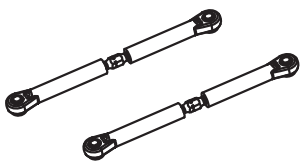

Alum Steering Linkage

**33606**

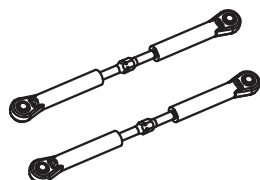

Alum Rear Upper Linkage

**E10MST-S2**

E10 Upgrade Set(Truggy, Truck, Monster Truck)



**31300**



Buggy Body ( Blue )

**31400**



Short Course Body ( Blue )

**31800**



Truck Body ( Blue )

**31500**



Truggy Body ( Blue )

**31301**



Buggy Body ( Red )

**31401**



Short Course Body ( Red )

**31801**



Truck Body ( Red )

**31501**



Truggy Body ( Red )

**31311**



Buggy Body ( Green )

**31408**



Short Course Body ( Green )

**31805**



Truck Body ( Green )

**31505**



Truggy Body ( Green )

**31312**



Buggy Body ( Blue )

**31409**



Short Course Body ( Blue )

**31806**



Truck Body ( Blue )

**31506**



Truggy Body ( Blue )

**31313**



Buggy Body ( Black )

**31410**



Short Course Body ( Black )

**31807**



Truck Body ( Black )

**31507**



Truggy Body ( Black )

**31303**



Transparent Buggy Body

**31402**



Transparent Short Course Body

**31802**



Transparent Truck Body

**31502**



Transparent Truggy Body





**1/10TH SCALE  
ELECTRIC OFF-ROAD  
BUGGY/SHORT COURSE/  
TRUCK/DESERT BUGGY  
TRUGGY/MONSTER TRUCK  
HUMMER/ON ROAD CAR**